

Amateur Radio Technician Class Training (Question Pool July 2018 – June 2022)

Slideset created by Alan Wolke, W2AEW
Permission granted for use by the MORE Project

Based on the No-Nonsense Technician Class
Study Guide by Dan Romanchik, KB6NU

Updates by Rebecca Mercuri, Ph.D., K3RPM



AMATEUR RADIO DIGITAL COMMUNICATIONS



Welcome to Session 3

Any Questions Before We Start?

Agenda

- Introduction
- Electrical Principles (EP)
- Electronic Components and Circuits (ECCD)
- Radio Wave Characteristics (RWC)
- **Antennas and Feed Lines (AFL)**
- **Amateur Radio Signals (ARS)**
- Electrical Safety (ES)
- Radio Practices and Station Setup (RPSS)
- Station Equipment (SE)
- Operating Procedures (OP)
- Rules and Regulations (RR)

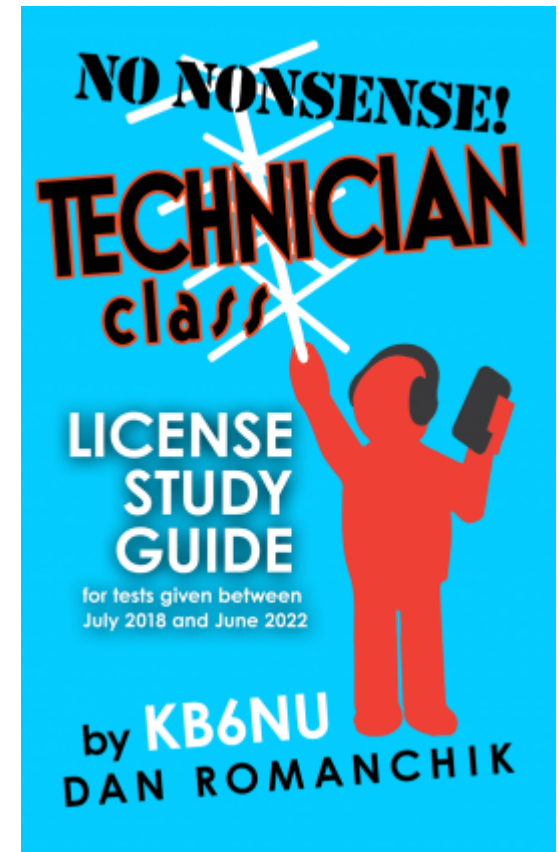

Antennas & Feedlines (AFL)

- Types & Polarization
- Feedlines & Connectors
- SWR & Measurements

Antennas & Feedlines

- Most Common:
Half-wave dipole
- Horizontally *polarized* when mounted parallel to earth
- Radiation is broadside to antenna

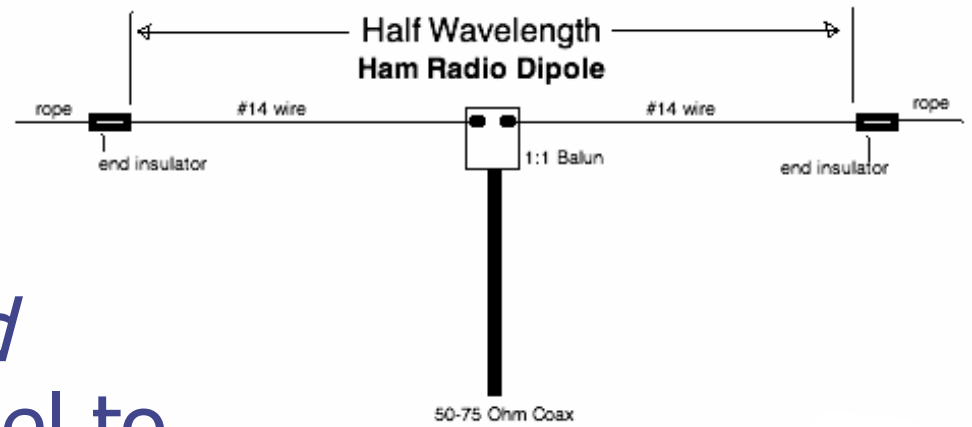

Half-Wave Dipole Details

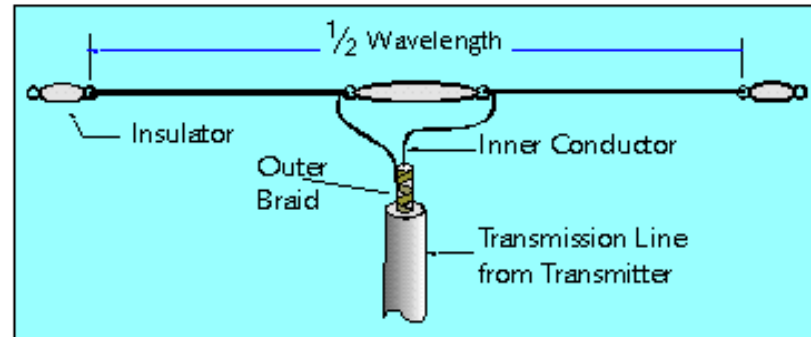

dipole antenna

- About 5% shorter than free-space half-wavelength
- Example: a *6m* dipole is about *112"* long
- To make it *resonant* on a *higher* frequency, you would *shorten* it
- $L(\text{ft}) = 468 / F(\text{MHz})$

Vertical Antennas

- Typically $\frac{1}{4}$ wavelength tall
- Vertically polarized, meaning the electric field is perpendicular to the earth
- A 2m vertical is $\sim 19''$ long
- $L(\text{ft}) = 234 / F(\text{MHz})$

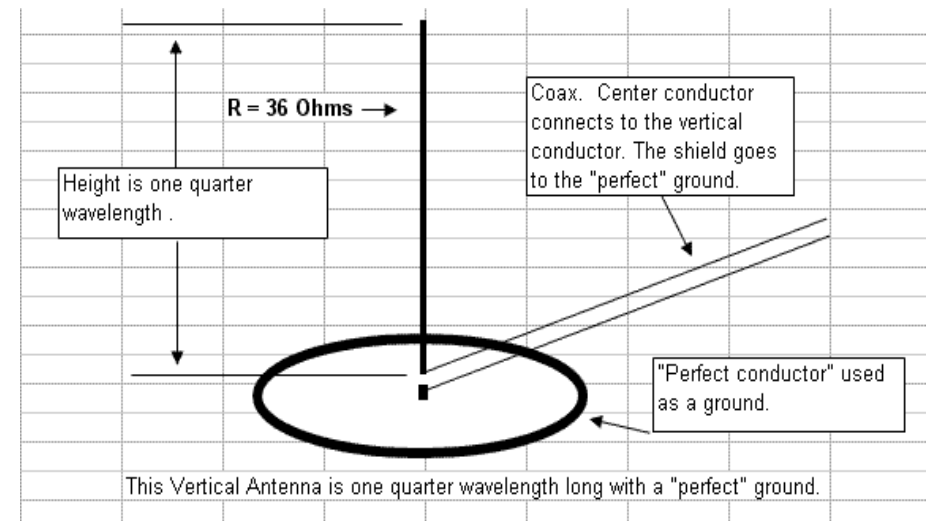
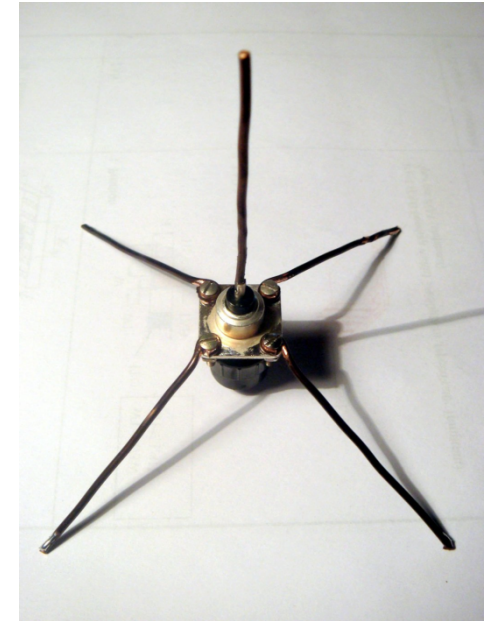

HF Antennas

- Can be very long!
- Loading is often used to physically shorten an antenna

Inductors (*in series with radiating element*)

Capacitors

- Loaded antenna not as efficient as full size



Beam Antennas

- Concentrates energy in *one* direction
- *Quad, Yagi and Dish* are all **directional** antennas
- **Gain** is the increase in signal strength w.r.t. a reference antenna



A Cubical Quad Antenna

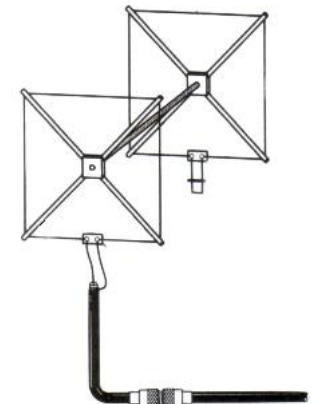

“Rubber Duck” Antenna

- Flexible antenna on most handheld transceivers (HTs)
- *Disadvantage:* not as efficient as a full sized antenna
- Good reason **not** to use in a car is that the signals will be much **weaker** as compared to outside the vehicle



A properly mounted 5/8-wavelength antenna provides lower radiation angle and more gain than 1/4 wavelength antenna for mobile use

Feedlines

- **Coaxial** cable is used most often because
 - It is easy to use
 - Requires few special installation considerations
- Mainly used to *carry RF* between *radio* and *antenna*
- **Loss** in cable increases as frequency increases
- **Impedance** of feedline ideally matches the impedance of the transmitter and antenna – most common is **50 ohms**

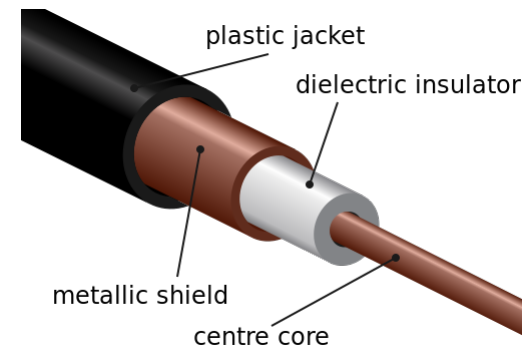
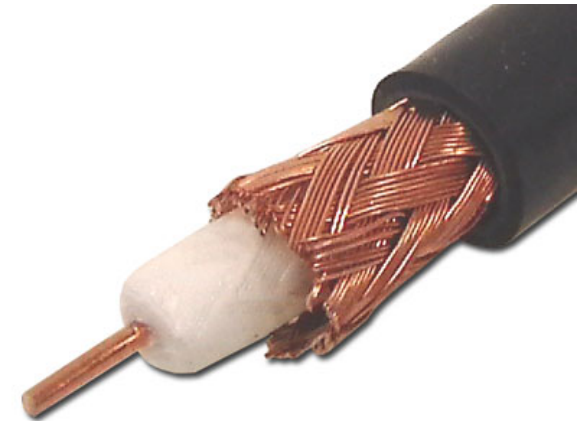

Common Coax Types

- **RG-58** and **RG-8** are the most common
- *Both* are 50 ohms
- RG-58 is thinner, but *higher loss* than RG-8
- Coax with lowest loss for **VHF** and **UHF** is *air-insulated hardline*

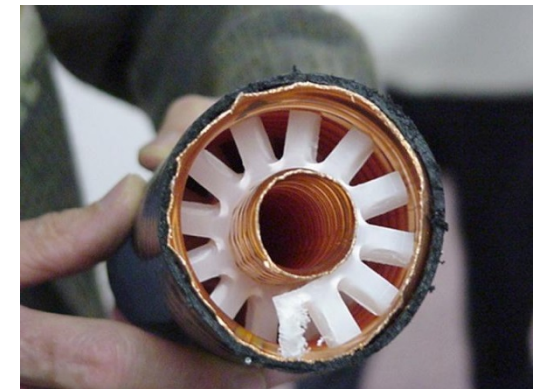

Common Coax Failure Modes

- **Moisture contamination**

 - Cracks in jacket

 - Around connections

- Jacket needs to be **UV resistant** to prevent cracking

- Air-Core coax requires special techniques to prevent water absorption

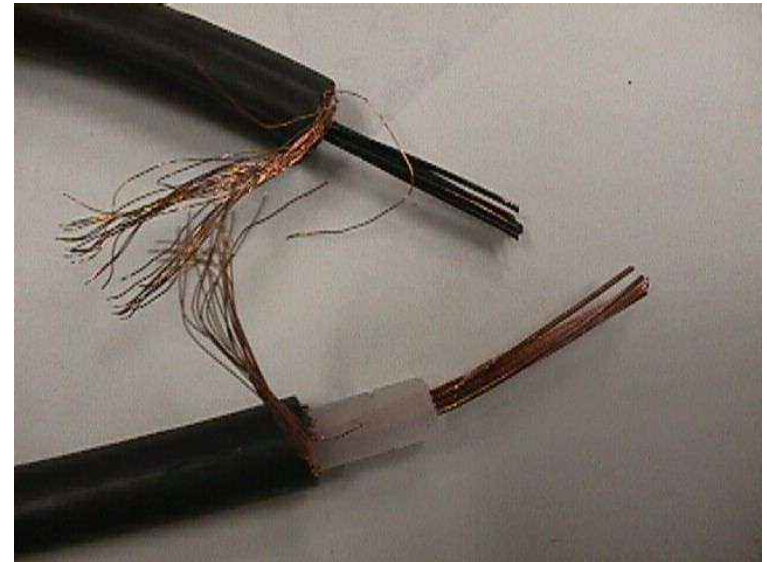

Common Coax Failure Modes

- **PL-259** is most common for **HF frequency** use
- PL-259 is not the most suitable at higher frequencies
- **Type-N** connector is most suitable above 400MHz
- Take care to *seal against water intrusion* to prevent increase in feedline loss
- **Keep 'em tight** – loose connections can cause *erratic SWR* readings



Standing Wave Ratio (SWR)

- A measure of how well **matched** a *load* is to the *transmission line*
- *Low SWR needed* with coax feedlines:
 - Efficient power transfer*
 - Minimize losses*
- Power *lost* in a feedline is converted to **heat**

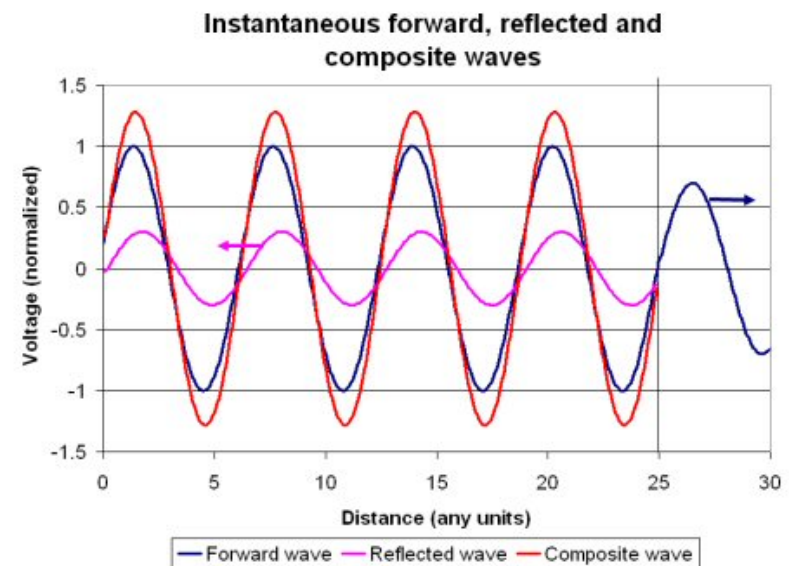

SWR Measurement

- SWR is measured with an **SWR meter**
- SWR meter is connected between the *transmitter* and *feedline*
- A **Directional Wattmeter** can also be used to determine if a feedline and antenna are matched properly
- **SWR** of 1 to 1, or 1.0:1 is a **perfect match**
- SWR of 2:1 or more is where *protection circuits* in most solid-state transmitters will *reduce power to protect output transistors*
- *SWR* of 4:1 means there is a large **impedance mismatch**
- An **antenna tuner** is used to match the antenna system impedance to the transmitter



More Measurements

- An **antenna analyzer** is commonly used to measure:
 - SWR
 - Antenna resonant frequency
 - Capacitance
 - Inductance



Dummy Load

- A Dummy Load is just a big 50Ω resistor
- Used to *prevent putting signal on the air when testing*
- It is a *non-inductive resistor* and a *heat sink*



Antennas & Feedlines

Chapter End

Questions?

Let's Practice for the Exam!

Amateur Radio Signals (ARS)

- Modulation & Bandwidth
- Digital Modes

Amateur Radio Signals

Modulation Modes

Signal Bandwidth

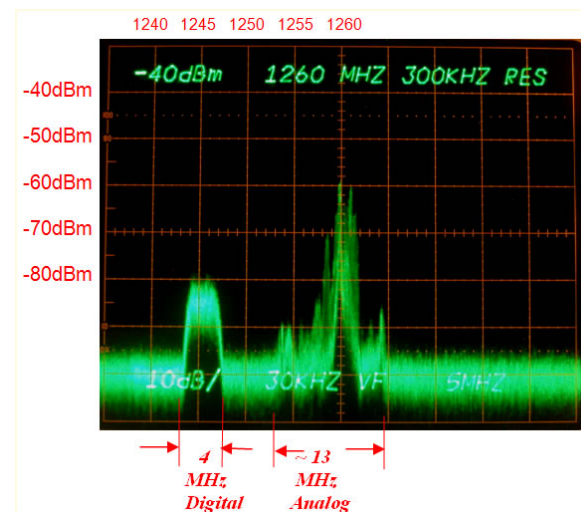
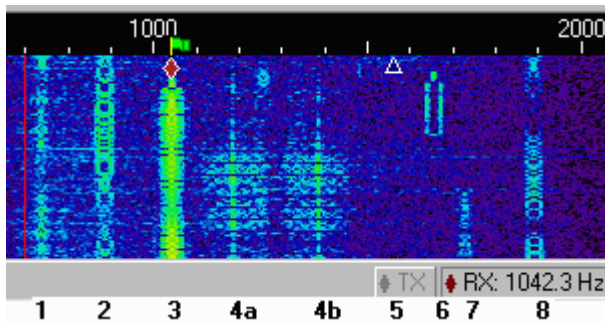
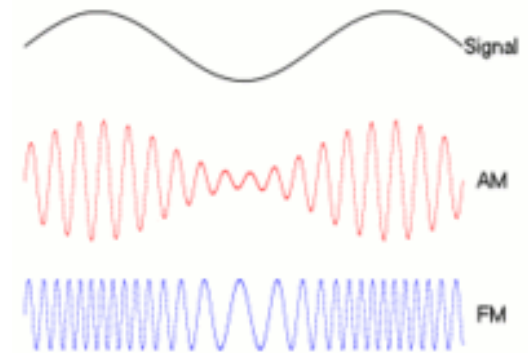

Modulation Modes: FM

- **FM** is Frequency Modulation
- Most common on *VHF and UHF voice* repeaters
- Also used for *VHF packet radio* transmissions

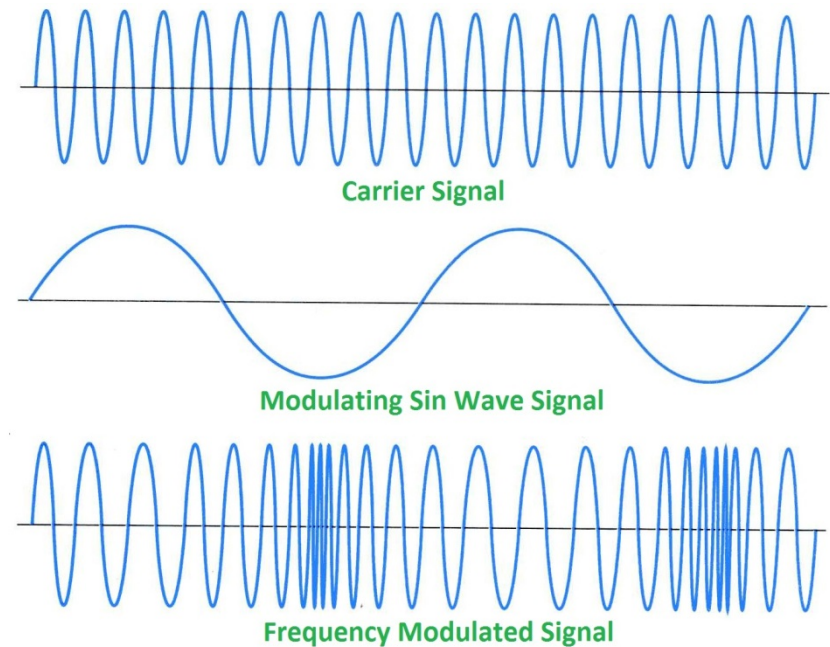

Modulation Modes: AM

- **AM** is **A**mplitude **M**odulation
- AM is one of the simplest modulation modes
- The *amplitude* (size) of the RF carrier is varied
- Energy is present at the carrier frequency and in sidebands on either side of the carrier

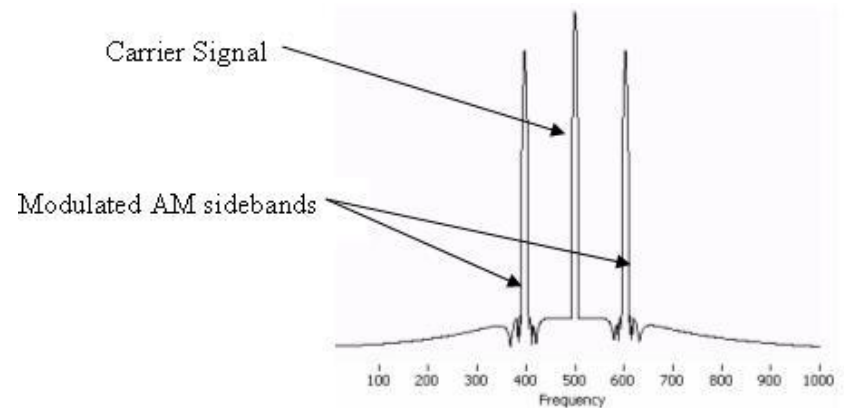
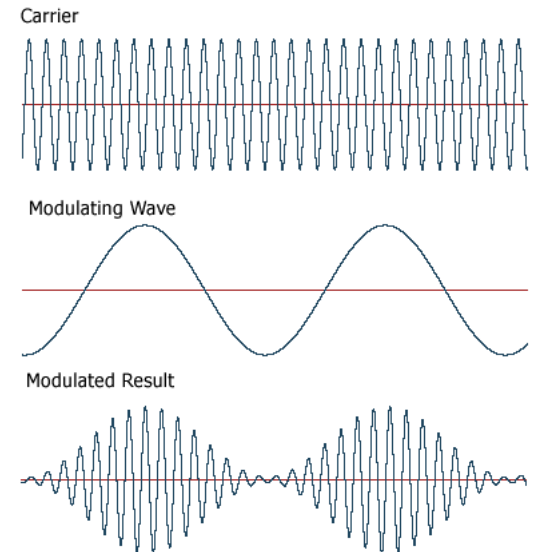

Single Sideband (SSB)



- **SSB** is a form of *Amplitude Modulation*
- Used for *long distance* and *weak-signal* contacts on *VHF & UHF*
- May be Upper or Lower (USB or LSB)
- **USB** used for 10m HF, and *VHF & UHF*

SSB Properties

- Advantage:
narrower bandwidth vs. FM for voice
- Typically $\sim 3\text{kHz}$ for *SSB* vs. 5-15kHz for FM

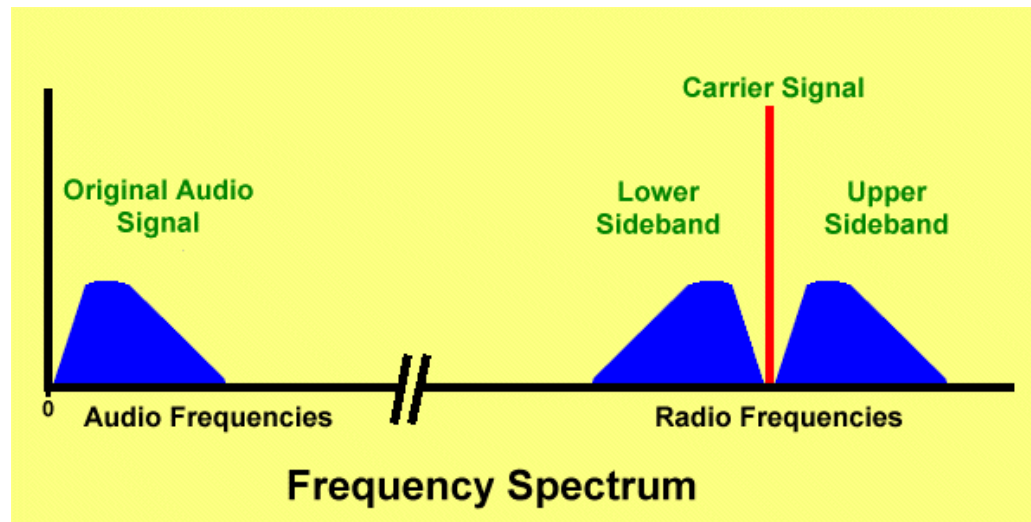

Continuous Wave (CW) Mode

Narrowest bandwidth (not really)
about **150Hz**

International Morse Code is
commonly used by Hams

CW can be sent using:

Straight Key

Electronic Keyer

Computer Keyboard



International Morse Code

- 1 dash = 3 dots.
- The space between parts of the same letter = 1 dot.
- The space between letters = 3 dots.
- The space between words = 7 dots.

A	• —	V	• • • —
B	• • • •	W	— • • •
C	• — • •	X	• • • — •
D	• — • •	Y	• • — • •
E	•	Z	• — • • •
F	• • • —	,	• • • • • —
G	• — • •	.	• — • • • •
H	• • • •	?	• • • • • •
I	• •	/	• • • — •
J	• — — —	@	• • • • • •
K	• • • —	1	• — • • •
L	• — • •	2	• • • — •
M	— • —	3	• • • • —
N	• — •	4	• • • • •
O	— • — •	5	• • • • •
P	• — • • •	6	• — • • •
Q	• — • • •	7	• — • • •
R	• • • •	8	• — • • •
S	• • • •	9	• — • • •
T	• — •	0	— • — • —
U	• • • —		

Amateur Television Modes

- TV signals can be sent in slow-scan and fast-scan modes.
- **Analog fast-scan TV** on 70cm band occupies *6MHz of bandwidth*
- **NTSC** refers to the encoding type of analog fast scan color TV signal transmission



Digital Modes

- Usually uses a computer and radio to communicate
- Data (not voice) is sent back and forth
- *Technician Class* can use **Digital** transmission on **219-220MHz**
- Some digital modes include **parity** – *an extra code element used to detect errors in reception*

Examples of Digital Modes:

- *Packet*
- *IEEE 802.11*
- *JT65*
- PSK31
- MFSK

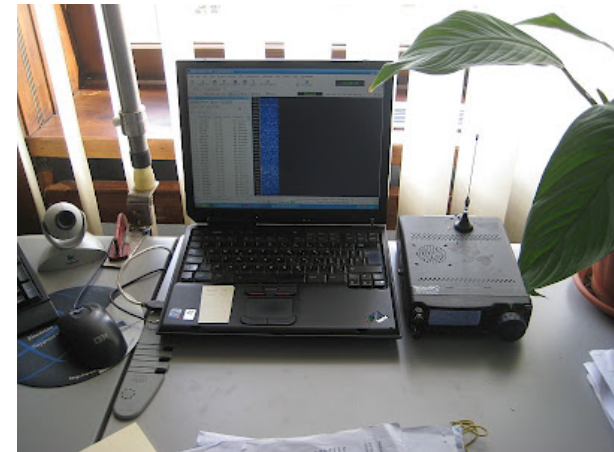

Packet Radio

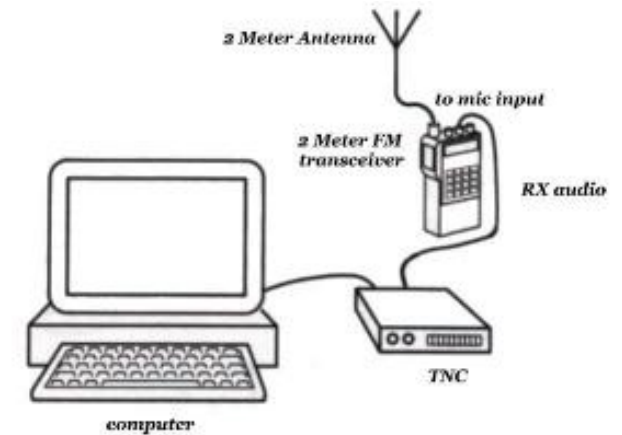

- One of the first digital modes
- Data grouped and sent in “packets”
- Packet radio includes:
 - A **check sum** which permits error detection
 - A **header** containing call sign of recipient
 - Automatic Repeat Request (ARQ)** in case of an error

APRS

- **Automatic Packet Reporting System**
- Uses Packet radio
- A **GPS** (*Global Positioning System*) receiver is used when sending position reports
- *Real-time tactical digital communications* along with *Map* showing location of stations

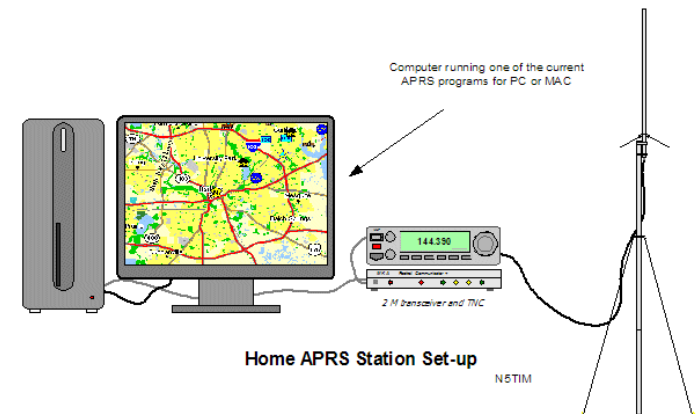
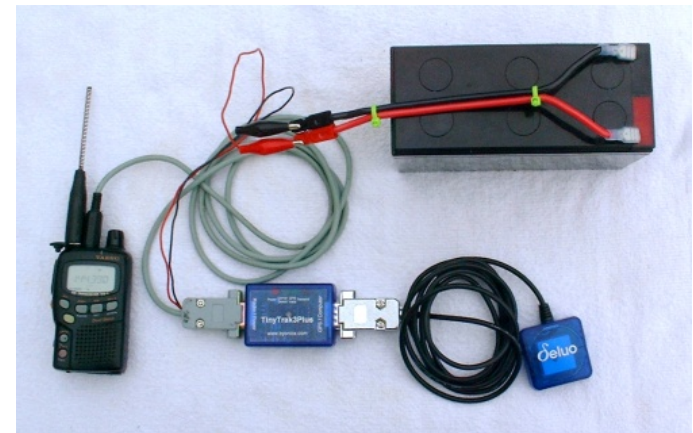

Phase Shift Keying (PSK)

- A digital modulation process that conveys data by changing the phase of the carrier wave
- Popular in HF band
- **PSK31** has *low-rate data transmission*

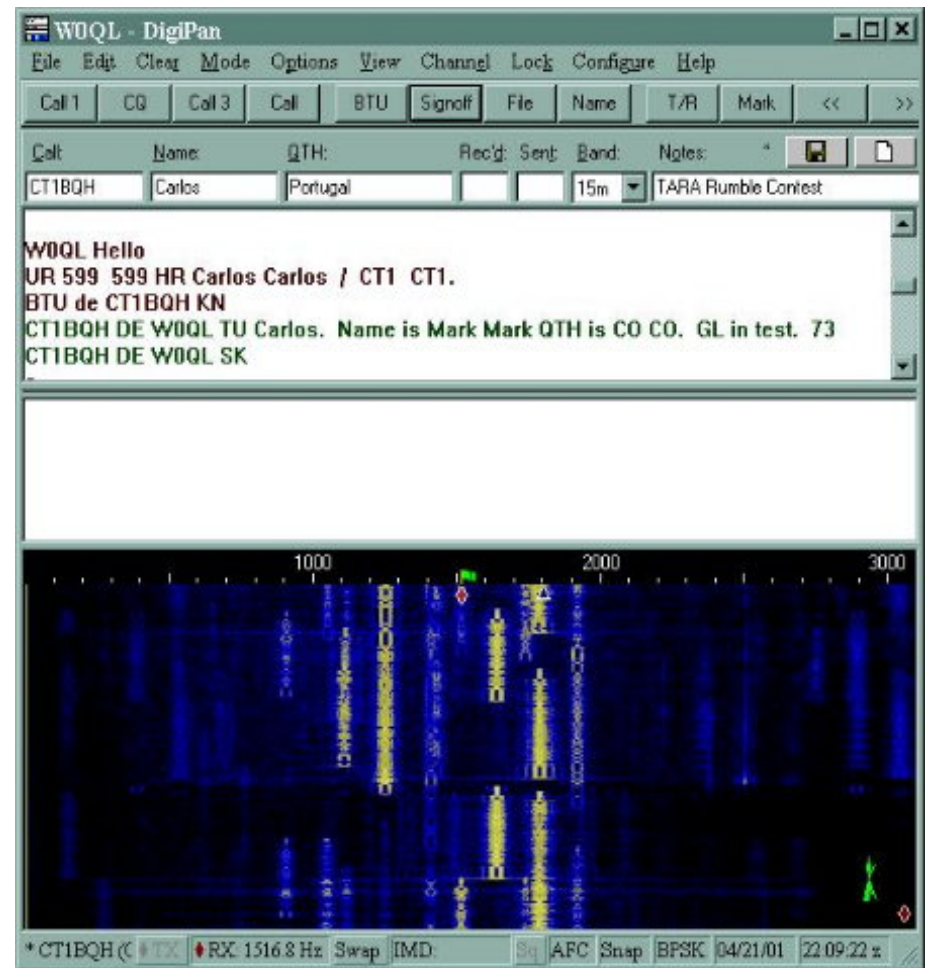

Digital Mobile Radio (DMR)

- FM Digital communications

Multiplexes two signals on a single 12.5kHz channel

- **Talk Groups**

Virtual channel – only heard by group of users in the channel

You *program* a **Group ID** into your radio to *join* the group

DMR
DIGITAL MOBILE RADIO



Weak Signal Modes

- **WSJT**

W e a k S i g n a l J o e T a y l o r

Slow transmission

Many applications:

Moonbounce (EME)

Propagation beacons

Meteor Scatter

- **FT8** is a weak signal that transmits on 15-second intervals

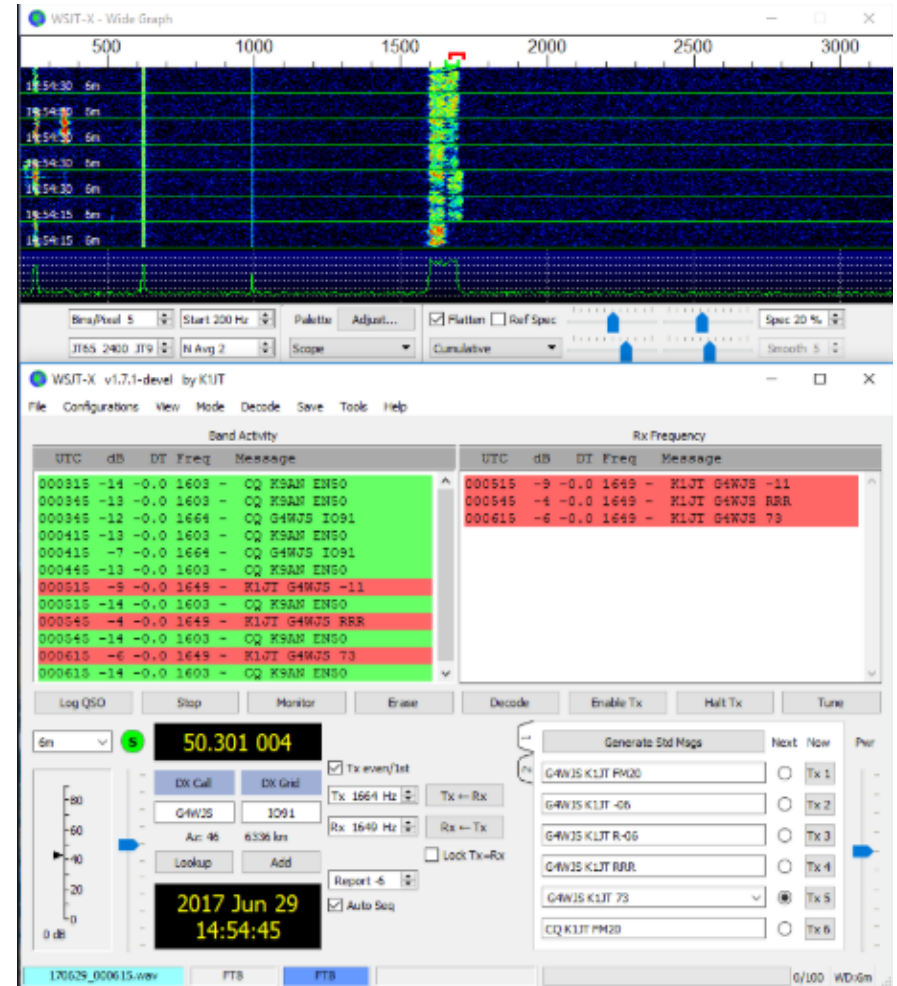

Mesh Networking

- Uses **WiFi** frequencies in 2.4, 3.4 and 5.8GHz amateur bands

Broadband-Hamnet

AREDN: Amateur Radio
Emergency Data Network

- Uses *WiFi hardware with modified firmware*

Broadband-Hamnet™
HSMM-MESH™



Amateur Radio Signals

Chapter End

Questions?

Let's Practice for the Exam!